

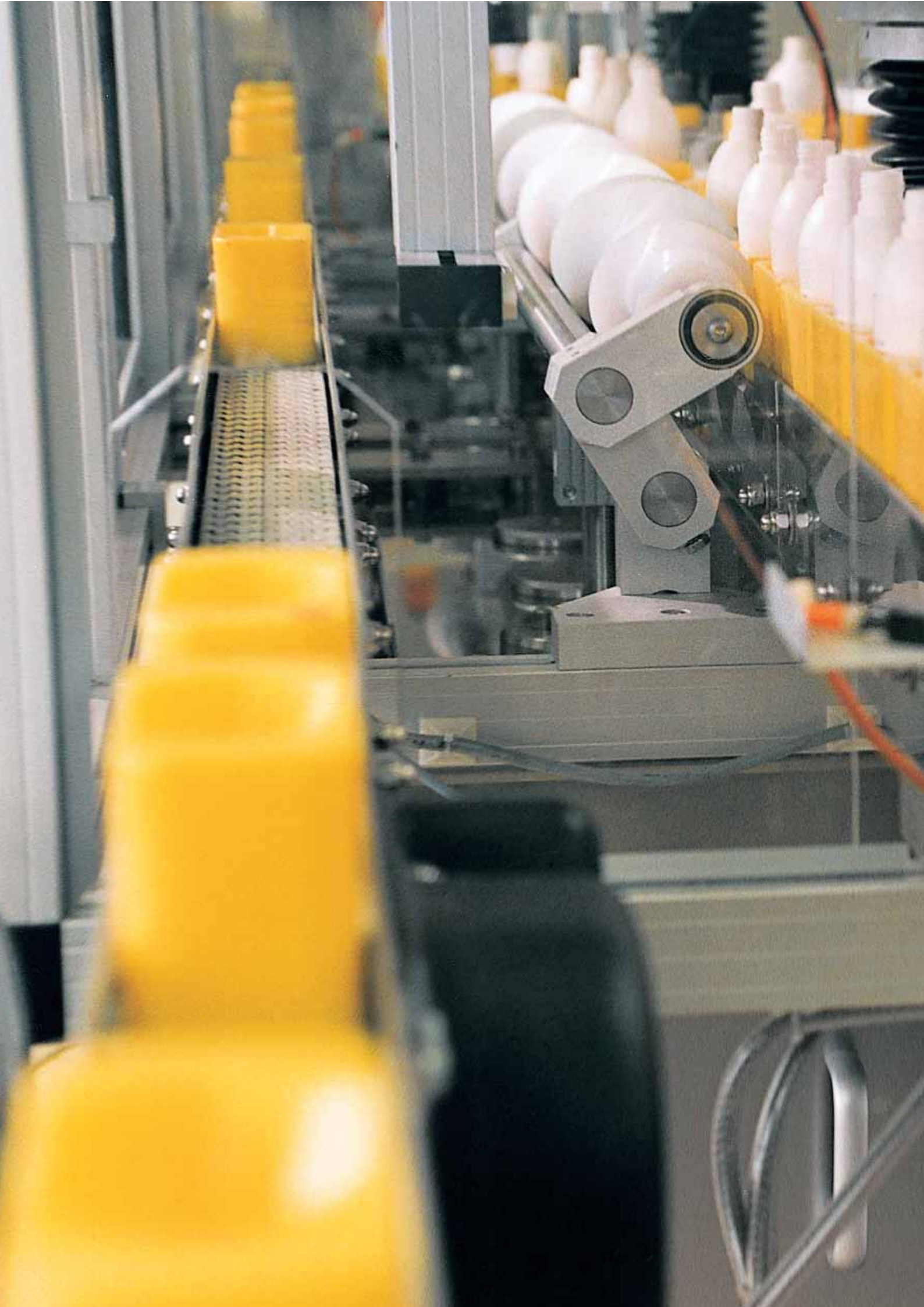

Sartorius Combics Pro The new terminal with more application performance





Combics Pro – it's basically better

Operation of the Combics Pro terminal is very straightforward. Color-supported, clear texts for operator guidance are a visibly new feature, and new programming approaches – for non-programmers as well as professionals – are a highlight as well. Take our word for it: EHEDG won't be able to find fault with our hygienic design.



Programming made easy – in high-level language (IEC61131) or via graphic elements. Programs will work even without well-established programming skills.



Find your way around without losing time – you'll have complete control of all the operating elements, and all results are displayed in a large, clear readout.

Quality housings begin with a quality material: IP67-rated stainless steel. The housing is designed so that there are no "dirty corners" and the terminal can be easily and reliably cleaned.



You'll always find the right interface – whether in the network or for point-to-point connection. It's your choice.

The four elements of the new Combics Pro terminal

Hygienic design in accordance with HACCP and EHEDG

Simplest programming via clear, graphic symbols

Intuitive prompts for operator guidance via the large color display

Worldwide programming support available at all times

You know what level of quality you require in production – we know that your processes have to run flawlessly. The best is just good enough to avoid errors that have wide-reaching consequences.

We've taken all the requests and demands that we've gathered and analyzed in the past and implemented them in the new Combics Pro. In the process, we considered how a premium terminal today should – and can – prove leadership quality in the premier league.

No matter what your individual requirements and demands are, Combics Pro is "completely" in its element in every case.

Effective immediately, our field representatives are available to demonstrate this terminal to you. With its top performance features, it has certainly earned first place in the premier league. The new Sartorius Combics Pro is waiting for you!



Service Plus

- Wherever questions arise, whenever you need service, we're nearby... all over the world
- Support provided during and after startup
- Support for connection to higher-ranking systems
- Programming provided by Sartorius (engineering)

Electronic features

- State-of-the-art processor technology
- Built-in fail-safe power supply
- Optional 24V power supply
- Integrated verifiable memory
- 2nd internal scale function
- Up to 62 additional external scales can be connected

Fully graphic creation of programs

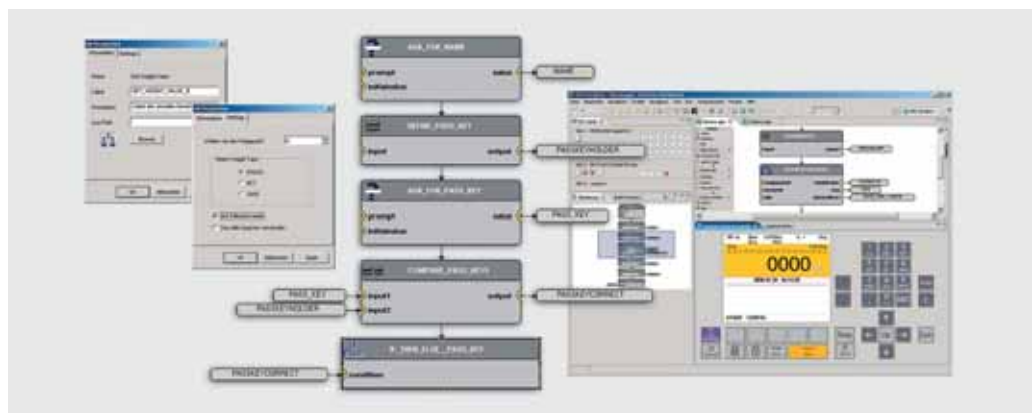

More application performance

Programming cannot and should not be viewed as a book with seven seals. That's why we've put considerable effort

into creating a simple programming structure. For those users with less programming experience, programs are created via graphic function modules – step by step. Programming in high-level language (IEC61131)

is just as transparent. Editable, prefabricated Sartorius software modules are additional components in a clear-cut structure – with the objective of making work easier and more reliable.

Software | applications

- Data memory for databases
- Programs are flashed into the EPROM, not burned in
- Simple, consistent operating philosophy for all applications

- Standard application programs available, e.g., Count (counting, checkweighing, totalizing) or Batching (manual recipe, automatic batching), or Phase (manual recipe, automatic recipe and batching, with connection to the Batch-management system ProBatch+)

- Software tools (Power Tools) for configuring printouts, loading programs into the terminal, transferring and editing databases, storing data on the PC, remote operation on the PC and simple translations of text shown in the display

Clean terminal

- AISI 304 stainless steel, IP69K protection rating
- Alphanumeric keypad with scratch-resistant overlay that keeps its shape
- Hygienic design without corners or edges
- Cable glands (direct plug-in connectors possible)
- Can be installed in a control panel



Power Tools

As soon as you've installed and started up the Combics Pro terminal, you'll have high-performance function packages at your fingertips. It's your guarantee for a smooth start and operation that is free of interference.

You can choose from:

- FlashIt** – for real-time updating and extension of the terminal controller software
- SNLE** – for creating reports, labels and more
- VNC Viewer** – for operating the terminal via a PC
- poEdit** – for changing all text displayed on the user interface
- ConfigureIt** – for backing up data and ensuring operability
- AccessIt** – for creating and editing terminal tables on the PC

Handling Pros

- Simple, intuitive prompts for operator guidance in the language of your choice
- Clear organization of keys and controls so that you can find your way around fast
- Large color display enables clear viewing of weight readouts and information
- High-contrast, backlit, graphic display
- 20 mm | 35 mm-high weight readouts can be clearly seen at greater distances
- Color bar graph display (yellow | green | red)
- Large keys featuring high-contrast labeling, positive click action and acoustic confirmation

Multi-connectivity

- Modular interface technology with digital and analog input and output
- RS-232C, RS-485, and RS-422 serial interfaces
- 6 interfaces can be connected internally
- Connection for PS/2 keyboard comes standard

- Bar code scanner can be connected
- Can operate in a network
- Ethernet (TCP | IP and ModBus-TCP)
- Profibus DPV1 | Interbus | DeviceNet

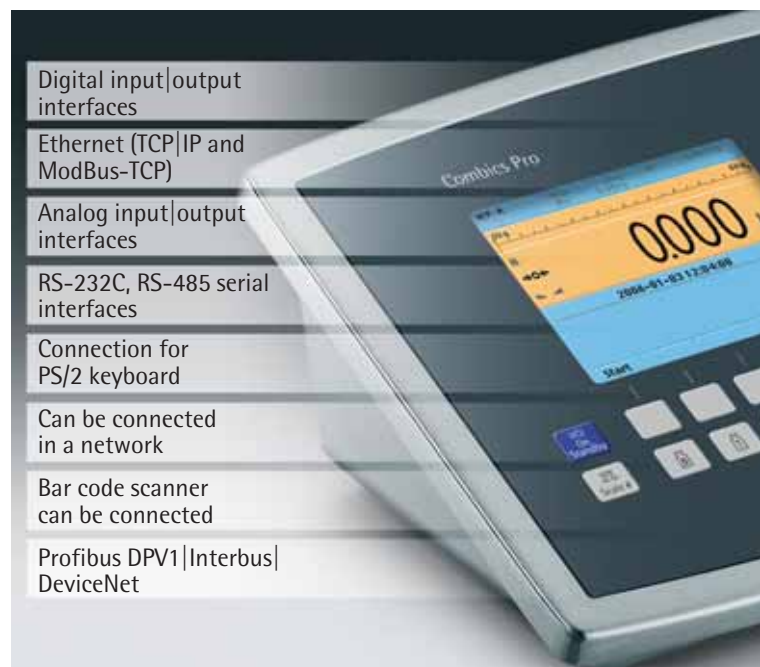

Specifications

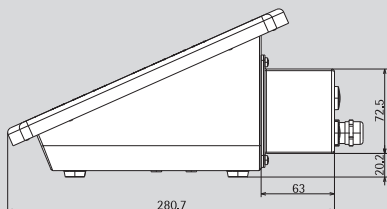
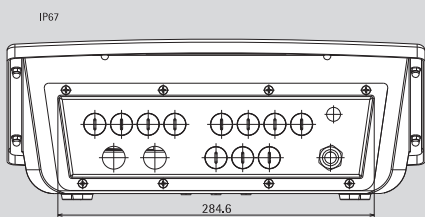
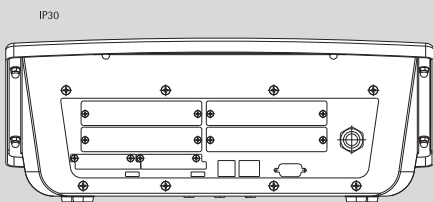
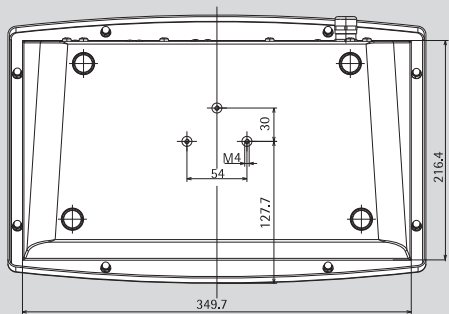
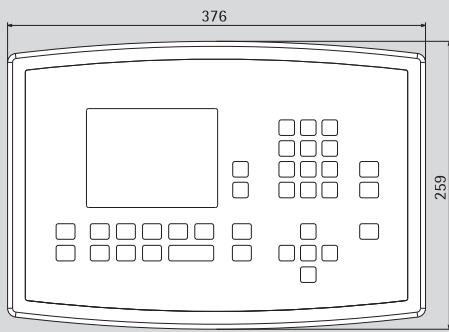

Display	Color graphic display with 320 × 240 pixels, backlit, 20 mm digits plus status icons, bar graph
Data interfaces	Bidirectional RS-232C, Ethernet and PS/2 installed as standard equipment
Digital non-reactive interface	In accordance with EN45501
Additional data interfaces	Optional (2 × A/D converter, RS-232C, RS-485, RS-422, analog inputs/outputs, digital inputs/outputs, Interbus, Ethernet, DeviceNet)
Housing material	AISI 304 stainless steel
Protection rating in accordance with 60529	Front plate: IP67 Back panel: IP30, IP69K available as an option
Dimensions (width × depth × height)	377 × 260 × 145 mm
Temperature range	-10°C to +40°C
Power supply	100-240 VAC (-15/+10%), 48-62 Hz, 14.5 W/19 VA
Power cord length	3 m
Net weight (approx.)	3.8 kg
Emissions	In accordance with EN61326+A1 Class A (IEC61326+A1)
Immunity to interference	In accordance with EN61326+A1, industrial areas (IEC61326+A1)
Electrical safety	In accordance with EN61010-1 (IEC 101-1), EN60950 (IEC 950)

Accessories

	Order no.
Combics Pro terminal: high-contrast, backlit, color graphic display with 320 × 240 pixel resolution, alphanumeric keypad with ABC input, 5 soft keys, RS-232C, Ethernet and PS/2 standard interfaces. Optional: 6 additional interfaces can be plugged in	CISPRO
Application Kits	
Phase application kit: for manual and automatic batching and recipe management, with S88-Interface for connection to the batch management system ProBatch+ (for Combics Pro the option E6 (OPC-Server) is automatically delivered additionally, free of charge	14
Counting application kit: checkweighing, totalizing, 6,000 product memories, 10,000 tare memories	15
Batching application kit: manual recipe, automatic recipe, material-, recipe and order data base, enhanced report function	16
Interface modules	
Analog/digital converter, incl. grounding plate, PR5800/10	940535800101
Serial interfaces, (RS-232C/485), PR5510/04	940535510041
1 analog output/4 analog inputs, PR5510/07	940535510071
BCD-out open emitter, PR5510/08	940535510081
BCD-out open collector, PR5510/09	940535510091
6 control inputs/12 control outputs, opto/opto, PR5510//12	940535510121
Ethernet, 10M baud, PR5510/14	940535510141
Profibus, PR1721/31	940531721311
Interbus, PR1721/32	940531721321
DeviceNet, PR1721/34	940531721341
CC-link, PR1721/35	940531721351
Printer and printer accessories	
Verifiable strip/label printer with thermal direct print head; accommodates paper widths up to 60 mm, with external 100–240-volt power supply, power cord required: YCC03-D09M6	YDP04IS-OCEUV
Verifiable strip/label printer with thermal direct print head; accommodates paper widths up to 108 mm, with external 100–240-volt power supply, power cord (EU+US); can only be used with the flexible printout configuration function; power cord required: YCC03-D09M6	YDP12IS-OCEUV
Verifiable strip/label printer with thermal direct print head; accommodates paper widths up to 108 mm, with external 100–240-volt power supply, power cord (EU+US); can only be used with the flexible printout configuration function; power cord required: YCC03-D09M6	YDP12IS-OCEUVTH
Verifiable strip/label printer with date and time functions and statistics program; power cord required: YCC03-D09F6	YDP03-OCE

	Order no.
Electrical accessories	
Bar code scanner; with power cord, 120 mm scanning width YCC03-BR02 adapter cable required	YBR02FC
Cable junction box, stainless steel, for connecting up to 4 weigh/load cells in a platform or for external installation PR 6130/64S	940536130642
I/O relay module for 12 relay outputs and 6 inputs PR 1613/20	940531623201
Other accessories	
In-use dust covers (pack of 2)	YDC02CISPRO
Cable gland for cables with diameters of 4.5 to 9 mm, IP67 protection rating, M16 × 1.5	YAS04CIS
Application software	
Internal Alibi memory (license), PR8901/81	940538901811
OPC server (license), PR1792/13	940531792131
Power Tools, PR8001/01	940538001011
Software	
Sartorius NICE Label Express software for flexible configuration of printouts on a PC and transfer to the operator terminal or scale	YAD02IS
Mechanical accessories	
Plug/socket set to connect platforms to the indicator	YAS991
IP69K kit	YAS01CISPRO
Kit for installation in a control panel	YAS04CISPRO
Front plate for flush mounting	YAS05CISPRO
Stainless steel wall retainer	YAS06CISPRO
Floor-mounted column, height: 1.1 m	YDH03CIP
Stainless steel floor-mounted column, height: 1.1 m	YDH03CIS
Base for installing the floor-mounted column, stainless steel (4 bars)	YBP03CIS
Retainer for bar code scanner; for attachment to floor-mounted column, bench stand, or complete scale retainer	YBH01CWS
Plate for attaching a printer to the floor-mounted column or bench stand	YPP01CWS
Cables	
We offer an extensive range cables for various requirements	

Sartorius AG
Weender Landstrasse 94–108
37075 Goettingen, Germany

Phone: +49.551.308.0
Fax: +49.551.308.3289

www.sartorius-mechatronics.com